



# *The Grid Leak*

## *October/November/December-2019*

*MEETINGS*

*VINTAGE  
HOUSTON*

*POST HOLIDAY  
PARTY*

*VRPS ANNUAL  
CONVENTION*

*2020 HVRA ANNUAL  
CONVENTION*

### ***From The President.....Bill Werzner***

With those lazy, hazy, crazy, and HOT days of summer now fading into the past, fall is in the air and fall activities await us. We made it through the summer and had a great time during the annual Texas City Ham Fest and our summertime auction in July at the Doyle Convention Center. Again our members came through bringing this time honored event to a successful conclusion. I don't have the facts or figures in front of me, but with the number of attendees and quantity of items auctioned, it was one of the best in several years. Again I want to thank all of you who devoted time and labor on that hot July day in Texas City. Then we suffered through what seemed to be the hottest August followed by an equally hot September in memory. Now we can anticipate those great autumn days and thank the good lord no major hurricanes came our way – so far. Yes, that nasty rain maker Imelda, late last month, did a number on us. I hope you all survived without having serious flooding. Did anyone lose their vintage radios to Imelda? Have you heard of any members canoeing around the bayous or boating around Galveston Bay trying to snare tube collections that possibly floated away? I certainly hope not!

Now looking ahead we will have our regular Saturday meetings in both October and November (for the first time in years), due to Thanksgiving coming late this year. Also in November we will, as in the past, participate in Vintage Houston's annual extravaganza at the Hobby Airport Museum Nov. 8 & 9. The following weekend our sister club, the Vintage Radio and Phonograph Society, will hold their convention and auction in Plano, TX. I hope we will have a good turnout and support our VRPS friends during their convention next month. There will be no Saturday regular meeting in December, but there will be a Board Meeting followed by a regular membership meeting with a program and auction on Tuesday evening Dec 10. Just like last year, pizza and snacks will be on hand for those who will miss dinner in order to attend. Looking ahead to 2020, our annual Christmas / Post Holiday party is scheduled for Saturday evening January 11 at the Hilton Double Tree Hotel. This will be a fun event for the whole family to attend so mark your calendar for a fun evening at the Double Tree! With that said, let's all have a Merry Christmas, Hanukkah, Kwanzaa, or whatever you choose. Above all, be safe and have a very Happy New Year!

***From the Editor:*** Hollywood has done it again. After a failed release in 2017, Hollywood has re-released "The Current War", **beginning on October 25th**. Benedict Cumberbatch is Thomas Edison, celebrity inventor on the verge of bringing electricity to Manhattan with his radical new DC technology. On the eve of triumph, his plans are upended by charismatic businessman George Westinghouse (Michael Shannon), who believes he and his partner, the genius Nikolai Tesla (Nicholas Hoult), have a superior idea for how to rapidly electrify America: with AC current. As they grapple for who will power the nation, they spark one of the first and greatest corporate feuds in American history, establishing for future Titans of Industry the need to break all the rules.

Judge for yourself and polish up for the HVRA Convention.....recognizing Westinghouse

## **HVRA Event Schedule: October, 2019 through February, 2020**

**Check our web site often for unexpected schedule changes, or special announcements.**

**Remember**, Board of Directors' meetings are open to all HVRA members. This is where you can share ideas, suggestions, or express concerns with our officers. Board of Directors' meetings are held on the 2nd Tuesday of each month at Bayland Community Center Library Room, 6400 Bissonet Street Houston, Texas from 6:30 to 8:30 PM. Pizza is served.

General Membership meetings are held on the 4th Saturday of each month, except for May, November and December when special arrangements may be made to avoid holiday conflicts. These General Membership meetings are held at the Bayland Community Center, 6400 Bissonet Street Houston, Texas from 8:30 to 11 AM. Although these meeting are for the benefit of members in good standing, HVRA encourages guests to attend and acquaint themselves with HVRA's activities. Members can participate in announced contests, presentations and auctions during these meetings. Coffee, juice, donuts and snacks are available.

### **OCTOBER**

**26th, Saturday, General Membership Meeting 8:30 AM - 11:00 AM**

Program: Bring your tube testers for a round robin tube testing comparison. Both emission and mutual testers are welcome. A series of six common radio tubes, some good, some weak, or defective will be provided by a club member for comparative testing  
Auction.

### **NOVEMBER**

**8th & 9th, Friday & Saturday, Annual Vintage Houston**

*Hobby Airport 1940 Air Terminal Museum, 8325 Travelair St. Houston 77061*

**12th, Tuesday, Board of Directors' Meeting 6:30 PM.**

**15th - 17th, Friday - Sunday, VRPS Annual Convention and Sunday Swap Meet**

*Comfort Inn and Suites 700 Central Parkway East, Plano, Texas 75074*

*See VRPS.org for complete Convention details*

**23rd, Saturday, General Membership Meeting 8:30 AM -11:00 AM;**

Program: "Output Transformers and Circuits." This will include single stage output, parallel and push pull, phase inversion, and general troubleshooting those circuits with hands on demos.  
Auction.

### **DECEMBER**

**10th, Tuesday, COMBINED BOARD AND GENERAL MEMBERSHIP MEETING 6:00 PM.**

Board of Director session 6 — 6:30 PM

General Membership Meeting and Auction 6:30—8:30 PM

Program: "Preparing Radios and Displays for the February Convention." Here is your chance to learn how to prepare displays, do touchup repairs, component cleaning techniques, literature preparation, etc. along with a question and answer session to follow.

Auction

### **JANUARY, 2020**

**11th, Saturday, HVRA Post Holiday Party and Banquet 6:30 — 9:30 PM**

*Hilton Doubletree Hotel at Hobby Airport 8181 Airport Blvd. Houston, 77061*

*Buffet Dinner, Music & Auction; Fun For The Whole Family*

**14th, Tuesday, Board of Directors' Meeting 6:30 PM.**

**25th, Saturday, General Membership Meeting 8:30 AM -11:00 AM;**

Program: "Quick Radio Troubleshooting Techniques" You will find this program valuable in getting that prize radio ready to boogie for the judges to hear, especially if it is one of those unpredictable sets that play great most of the time,

Auction

### **FEBRUARY**

**7th & 8th, Friday & Saturday, HVRA 2020 Convention, Marriott North, Houston**

**11th, Tuesday, Board of Directors' Meeting 6:30PM**

## **HVRA Officers**

**President:** Bill Werzner, 713-721-2242 [werz1943@gmail.com](mailto:werz1943@gmail.com)

**Vice President:** Lewis Brittain, 281-493-0737 [Brittfaml@juno.com](mailto:Brittfaml@juno.com) **NEW VP**

**Treasurer:** Richard T. Slater, 832-977-6111 [ricslater17502020@gmail.com](mailto:ricslater17502020@gmail.com)

**Secretary:** Mike Monsour, AC0TX, 832-829-2227 [msircg@gmail.com](mailto:msircg@gmail.com)

**Historian:** Steven Pena, [penas@stthom.edu](mailto:penas@stthom.edu)

**At Large # 1:** Reid Shipp, WA5ARI, 281-943-9877

**At Large # 2:** Tom Taylor, 281-229-2970 [ihcrally@yahoo.com](mailto:ihcrally@yahoo.com)

**Grid Leak Editor:** Jerry Sirkin, 281-844-4124 [gsirkin@aol.com](mailto:gsirkin@aol.com)

**Webmaster:** Steve Scheel, 281-687-5771 [targeteye1@gmail.com](mailto:targeteye1@gmail.com)

## **Annual Election of Officers September 28**

Positions were open for: Vice President (Convention Chairman), Secretary, and At Large Position II (Convention Contest Chairman). The following members were unanimously elected to the following Board positions: Lewis Brittain Vice President; Mike Monsour Secretary and Tom Taylor At Large Position II.

**Personal note from the Past VP.** I would like to thank Lewis for stepping up to be HVRA's new VP. Lewis is a longtime member of HVRA and has served in many capacities over the years, both as a member and as an officer. Lewis has held this position in the past and I'm certain that all of your expectations will be met. Please join me in welcoming Lewis to the Board. As outgoing VP, I will continue, through the Convention, in assisting Lewis and completing the transition. Thank you everyone for all your help over the past 5 years

## **Please Welcome the Following New Members**

**Joined 3rd Qtr, 2019:** Justin Hughes, Katy Brett Martin, Katy Robert McLeroy, Conroe

Paul deLacerda, Houston Mike Boses, Houston

## **Becoming a Ham**

By Jeff Heller

I do like to ham it up on occasion, I admit. But becoming one of those "other" hams was something I had on my post-retirement bucket list. I have been a shortwave listener for 50 years and I avidly collect and try to restore many of the communications receivers I would have loved to have when I was a teenager in the late 1960's and early 1970's. I always thought I would like to get my ham license but never did it despite being around so many hams in the radio hobby. This year, I took all three license tests—Technician, General and Extra Class—and I am happy to say that I passed all three tests. But it took a lot of study particularly to pass (at 100%) the Extra Class license. I learned a lot in that process the hard way with two months of study for the test. My original call sign was KI5CYX when I passed the Technician and General tests. After passing the Extra Class test, I applied for a "2x2" license and my call sign now is AG5WF. I am almost on the air now. I had to install a ground rod system in some pretty difficult situations where I live on top of rock in the hill country. My 40 meter dipole is finally ready to go. I do believe that getting my ham license has enhanced my radio collection hobby by expanding my knowledge base about all things electronic. For someone like me who did not work in the electronic field for a career, it was a great idea to get that ham ticket. My next goal is to learn code! 73, Jeff Heller.

## OUR SYMPATHIES GO OUT TO THE FAMILIES AND FRIENDS OF PAST HVRA MEMBERS

### JOHN ORAHOOD



**John** passed away on March 27, 2019, just about one month short of his 86th birthday. John was a longtime member of HVRA, a collector of all types of radios, a HAM radio operator (N5SPQ), a great conversationalist and avid reader. Earning a Mechanical Engineering Degree from THE Ohio State University and dual Masters Degrees in Finance and Real Estate from SMU, was prepared to take on any challenge. John married Ruth Vivian Markel in June of 1955 and raised five daughters. After spending time in the Air Force (Dayton Ohio), working for Union Carbide in West Virginia and Brownsville, Texas, his career continued through Midland, Dallas and finally, in 1975, Houston. On behalf of radio collecting community, HVRA wishes to extend our condolences to John's family.

### CLEO CHERRYHOLMES



**Cleo Dean Cherryholmes**, 89, of Sachse, Texas passed away on Friday, October 4, 2019, at Methodist Medical Center in Richardson, Texas with his family at his bedside. He was born November 14, 1929 in Crawfordsville, Iowa to Kenneth and Doris (Fletcher) Cherryholmes. Preceding him in death are his parents and a sister, Margery (Cherryholmes) Edgar of Crawfordsville, Iowa. On September 25, 1955, he married Wanda Woodard, who survives in Sachse, Texas. Also surviving are two children, Steven Cherryholmes of Dallas, Texas, Linda (Mark) Staller of Sachse, Texas; three grandchildren, Jennifer (Scott) Babus, Bethany (David) Bach, Katelyn Staller; three great-grandchildren, Logan Remillard, Olivia Grace Babus and Brayden Babus, brother-in-law James (Noy) Edgar of Craw-

fordsville, Iowa and several nieces and nephews. Cleo graduated from Crawfordsville (Iowa) High School in 1947 and received a Bachelor's Degree in Electrical Engineering from Iowa State University in Ames, Iowa in 1952. He was employed by Sylvania in Burlington, Iowa and later North American Phillips in Ottawa, Ohio as an electrical engineering manager for 41 years. After retirement in 1993, he moved to Sachse, Texas to be closer to his children. For several years in the mid-1950's, he served in the Army at their Electronics Proving Ground at Ft. Huachuca, Arizona. Cleo liked to play softball, basketball, tennis and ping pong. He was active in his church in Ottawa, Ohio, singing in the choir for 26 years. Also, while in Ohio, he was an active member of the local Kiwanis Club. After retirement in Texas, he joined the Sachse Lions Club and the Vintage Radio and Phonograph Club, where he enjoyed collecting and restoring antique radios. He was a member of First United Methodist Church of Richardson, Texas. Visitation will be Tuesday October 8, 2019 from 6:00 p.m. to 8:00 p.m. at Charles W. Smith & Sons Funeral Home, Sachse, Texas. Funeral Services are pending at Charles W. Smith & Sons Funeral Home in Sachse, Texas. Check back on [www.cwsfuneralhome.com](http://www.cwsfuneralhome.com) for service times. Services entrusted to Charles W. Smith & Sons Funeral Home of Sachse, Texas.

## VINTAGE HOUSTON



### Hobby Airport Museum Extravaganza Nov. 8 & 9

This will be our seventh year participating in Vintage Houston's annual fall, two day extravaganza at the 1940 Hobby Airport Museum, 8325 Travelair St., Houston, TX 77061. If you have never been to this museum before, you are in for a nostalgic treat with Houston's aviation history on display as the many exhibits roll back the pages of time prior to WW II. Inside the restored terminal, Vintage Houston will have all kinds of vintage clothing, jewelry, artifacts, memorabilia, etc. from a bygone era for the whole family to enjoy. There will be entertainment that includes a style show, beauty contest, music and dancing. HVRA will exhibit vintage radios, records, and literature for show and sale, and provide music of the era as well! Activities will start at 5 PM on Friday and continue until 11 PM. On Saturday, the museum will open from 10 AM until 5 PM. Food vendors will be on hand along with exhibits in the front plaza, while airplane rides and exhibits are in the tarmac area behind. There is a small admission fee for the event that we encourage you to support. Bring family and friends – including the kids for this annual fun event that I'm sure everyone will enjoy! To get there, take Telephone Road south from Loop I – 610. For additional information go to [www.vintagehouston.com](http://www.vintagehouston.com).



## POST HOLIDAY PARTY TIME ONCE AGAIN

Yes, our annual post Christmas/Holiday Party will be held at The Double Tree Hotel near Hobby Airport located at 8181 Airport Boulevard, Houston, TX 77061, on Saturday evening January 11, 2020. The dinner will commence at 7pm followed by our usual, "UNUSUAL" auction. We will have a social hour beginning at 6pm for all those who would like to visit before dinner. This year we will again have a great banquet catered by the hotel just like in years gone by. I met with Catering Manager Latishia Evans who assured me that we will be served the delicious Southern Comfort Dinner Banquet that everyone raved about last year. This menu features their famous rosemary baked chicken, beef tenderloin, buttermilk mashed potatoes, soups, salads, and all the trimmings. Dessert includes peach cobbler and pumpkin pie (those dessert items are great too). The food is served buffet style and I guarantee you won't go away hungry. We encourage you to pre-register before the deadline of Friday, December 27th for the \$25.00 discounted meal ticket. After that deadline, our \$5.00 subsidy will end and the tickets will increase to the hotel's cost of \$30.00. For children under 12, the cost will be \$12.00 per ticket until the time of the banquet. Please sign up early by filling out the form below, including a check for tickets payable to HVRA, and mail to our post office box: HVRA, P.O. Box 31276, Houston, Texas 77231-1276. We would very much like to have a head count by December 29th as this will help us greatly in committing to the event.

To get there from Houston, take Telephone Road south from I-610, turn left on Airport Boulevard, go past Hobby Airport entrance stop light, then turn left at the second stop light on Ruthby Street and enter the hotel's parking lot. Park in the lot on the east side of the Hotel near the side entrance.

**Auction Manifest for Party:** To help subsidize this event, as we have requested in the past, we ask that you donate one or two radio / electronic items, and one non radio item, for our fun auction. The auction has been one of the highlights of our party. We would like you to send some photos of the items you plan to donate so we can publish them prior to the party on the HVRA.org website. Please forward photos to our Webmaster, Steve Scheel at targeteye1@gmail.com.  
**For additional information contact Bill Werzner, 713-820-1778 or werz1943@gmail.com**

**HVRA 2020 Post Holiday Party January 11, 2020 7PM—9:30PM**

**Preregistration Form**

**Due By Friday, December 27, 2019**

**Costs: Preregistered Adult \$25, Preregistered Child (12yrs and younger) \$12**

**After December 27th, Adults \$30, Child \$12**

**Make Checks payable to HVRA and send to P. O. Box 31276, Houston, Texas 77231-1276**

**For additional information contact Bill Werzner, 713-820-1778 or werz1943@gmail.com**

**Member's Name:** \_\_\_\_\_

**Number of adults attending, including member:** \_\_\_\_\_

**Number of children (12 yrs and younger) attending:** \_\_\_\_\_

**Total Amount:\$** \_\_\_\_\_ **Check Number:** \_\_\_\_\_ **Date:** \_\_\_\_\_

## THE LEARNING CURVE



**Again Lance Borden and Tom Taylor** had an opportunity to present tube related topics to attendees at Electronics Parts Outlet (EPO) on Fondren; this session on the topic of single tube radio construction. Specifically, it was suggested they offer kit fabrication and design basics to a mixed crowd with emphasis on building a foundation and confidence towards use of such a basic circuit. Despite threatening weather, fourteen attendees completed fabrication of their kits prepared by EPO and Lance himself as witnessed by parents and friends. The event was divided up into three parts the first of which was a brief history followed by related theory of most all involved in the radio operation. Followed by two construction sessions that later blended into one larger session for the benefit of those needing more time and those arriving late. Ages varied from preteen to about their late 40s and photo evidence seems to depict a smile for everyone there as they heard their own radio work. Our hope is to stimulate interest in electronic circuit construction and the inquisitive nature so important to those destined for careers in technical fields.

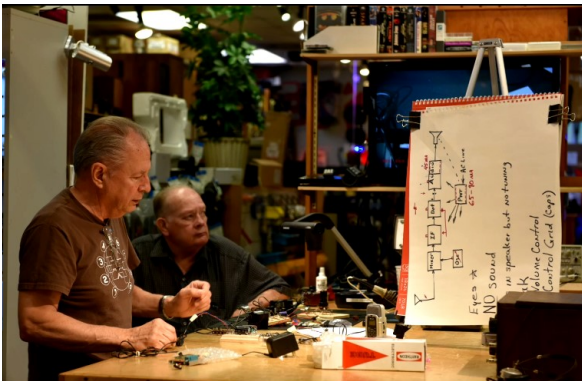

### Five Basic Electronics Classes At EPO



Following HVRA members Lance Borden and Tom Taylor's very successful class at EPO, HVRA president, Bill Werzner was approached by owners to hold several basic electronics classes prior to school restarting in mid August. Five, Tuesday and Thursday, afternoon classes were held starting July 30 and finished on August 15. These classes began with lessons in basic electricity, and progressed to reading electronic diagrams, schematics, identifying components, vacuum tubes, transformers, and solid state. The last class concluded with a lecture about the "All American Five" radio including basic trouble shooting techniques. These classes also included hands on demos along with take home printed material for home study. Many thanks EPO for hosting our series of classes. Perhaps we will be invited for a return performance in the future! Lance and Tom, are you ready for another try next year? I am ready, and as a team we really generated allot of interest in vintage electronics and HVRA.



## At the bench.....*The Troubleshooter by Bill Werzner*



### **“Don’t Pitch That Tube Until You Have Cleaned It”**

A couple of days ago I received a call from Vintage Sounds that a customer was buying one or more #26 tubes from our stock and that I needed to replace them. “No problem,” I replied as I knew I had bought three new old stock ones during the VRPS auction last fall. No trouble locating them as they were right in front of the other tubes in my vintage tube locker. I decided to give them a final check before boxing them up and labeling them for sale, so I hauled out my Knight 600 B tube tester. After allowing about a minute for warm up, I pushed the test button and to my dismay, the first one failed the emission test at only 35% on the scale of 100! Knowing that these tubes were probably ninety years old and stored out of box – no telling where, I decided to clean the tube pins even though they looked clean and shiny. I lightly brushed the four pins with a mild wire brush then brushed on some Deox IT contact cleaner from a small sample bottle I had on my work bench. I retested that first tube, and it pegged the meter past 100% when the test button was pushed! This tweaked my analytical German brain, so I began to wonder how many good tubes of that genre had been mistakenly tossed due to what was thought to be weak emission. The culprit here was obviously oxidation of the tube’s pins that was easily corrected and we know metal oxides are notoriously poor conductors.\*

The #26 tube requires 1.05 amps at 1.50 volts for normal operation. Plugging in Ohm’s law of  $R=E/I$ , the filament during operation comes in at 1.43 Ohms – not very much eh! Using simple ratio and proportion, if 1.50 volts is 100 %, then what would the filament voltage be at 35%? According to my calculation it would be about 0.53 or 530 mV! Now let’s see how very low filament pin resistances would affect filament voltage in a #26 radio tube:

$R= 0.05 \text{ Ohm}$ , Filament = 1.45 Volts.  $R= 0.10 \text{ Ohm}$ , Filament = 1.39 Volts.

$R= 0.20 \text{ Ohm}$ , Filament = 1.29 Volts.  $R= 0.30 \text{ Ohm}$ , Filament = 1.19 Volts.

This should be considered especially important when testing vintage tubes that require higher current and low voltage to light the filaments. Other tubes that come to mind are the 2A3, 27, 35, 45, 46, 47, 57 58 & 59. Other tubes that require higher filament voltages and lower current will suffer the effects of filament pin oxidation, but not to the extent of the types I have listed. What about the one volt battery set tubes such as the 1L6 or the octal 1LN5? The 1L6 miniature has a filament resistance of 28 Ohms during operation (0.05 A at 1.40 V).



### Continued from “Don’t pitch that tube until you have cleaned it”

With a filament pin corrosion resistance of 0.10 Ohm, the filament would be reduced by only 4 milli-volts! The same would apply to many other tubes of those types. Regardless of the tube, I make it a routine to clean the pins before installation or selling them to a customer. The loctal tubes seem to be especially vulnerable to pin corrosion and may require the use of emery cloth or sand paper to remove pin rust and corrosion. Again, I highly recommend painting or spraying the pins with Deox IT following brushing or sanding.

Some vintage tubes will test weak or as burnouts due to pin tip solder failure. This can be corrected by filing down the pins to remove the old solder and expose the copper wire inside. Apply some liquid flux and re – solder the wire end to the pin tips. I have saved a number of otherwise bad tubes by using this technique along with the procedure described above.

Diagram showing how filament corrosion will affect #26 triode tube filament function. When operating normally, the filament requires 1.58 Watts ( 1.05 A at 1.50 V.).  $R_{cr}$  represents ohmic resistance on pin surfaces prior to cleaning.

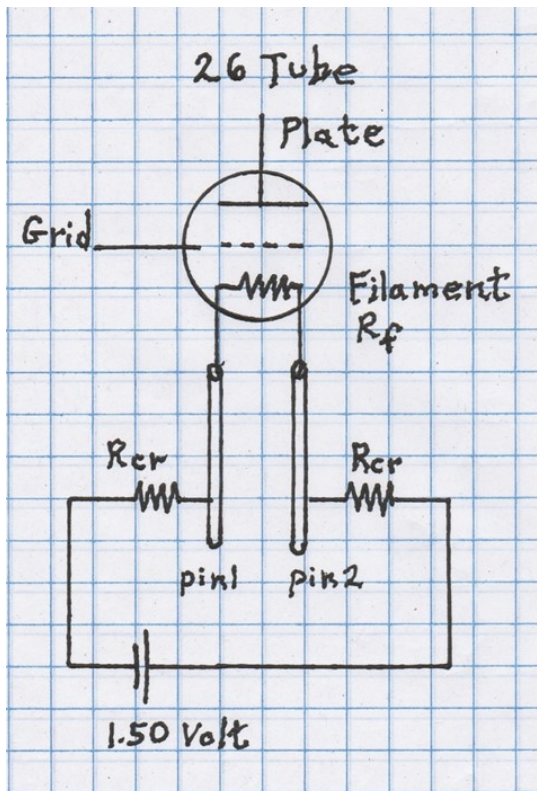

## The #27 Triode by Bill Werzner

In the last quarter "GL" I presented the detailed characteristics (curves) of the first commercially available #26 triode vacuum tube that could operate with a filament powered by AC current. Preceding the #26 by a few months, the five pin #27 triode was introduced by RCA in May 1927 (the #26 actually came along four months later in September). The #27 was not only unique with a five pin base, but was the first of the newly standardized tubes that utilized a heated cathode for electron emission. This tube has wide applications that include oscillator, detector, and audio amplifier. It is found in many late 1920's radios, test instruments, audio amplifiers, including vintage theater sound systems. Its use continued well into the 1930's. I decided to share this information that I found in a 1940's Tung Sol tube manual that you may find useful in trouble shooting or possibly modifying vintage radios or equipment from that era. Watch for the #71A output tube next quarter.

### TRIODE DETECTOR AMPLIFIER

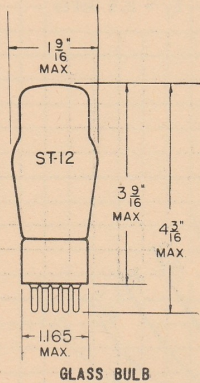

COATED UNIPOTENTIAL CATHODE  
HEATER  
2.5 VOLTS 1.75 AMPERES  
AC OR DC  
ANY MOUNTING POSITION

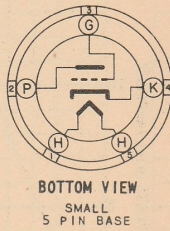

BOTTOM VIEW  
SMALL  
5 PIN BASE

THE 27 IS A GENERAL PURPOSE TRIODE DESIGNED FOR SERVICE AS AN OSCILLATOR, DETECTOR OR AMPLIFIER.

#### RATINGS

INTERPRETED ACCORDING TO RMA STANDARD HS-210

HEATER VOLTAGE	2.5	VOLTS
HEATER CURRENT	1.75	AMP.
MAXIMUM PLATE VOLTAGE	275	VOLTS
MAXIMUM HEATER-CATHODE VOLTAGE	90	VOLTS

#### DIRECT INTERELECTRODE CAPACITANCES WITH NO EXTERNAL SHIELD

GRID TO PLATE	3.3	$\mu\mu\text{f}$
INPUT	3.1	$\mu\mu\text{f}$
OUTPUT	2.3	$\mu\mu\text{f}$

#### TYPICAL OPERATING CONDITIONS AND CHARACTERISTICS

##### CLASS A AMPLIFIER

PLATE VOLTAGE	90	135	180	250	VOLTS
GRID VOLTAGE	-6	-9	-13.5	-21	VOLTS
PLATE CURRENT	2.7	4.5	5.0	5.2	MA.
PLATE RESISTANCE	11 000	9 000	9 000	9 250	OHMS
TRANSCONDUCTANCE	820	1 000	1 000	975	$\mu\text{MHOS}$
AMPLIFICATION FACTOR	9	9	9	9	

##### DETECTOR

###### BIASED

PLATE VOLTAGE	250	275
GRID VOLTAGE (APPROX.)	-30	-35
PLATE CURRENT <sup>A</sup>		
GRID RESISTOR:		
MINIMUM	---	---
MAXIMUM	---	---
GRID CONDENSER	---	---

ADJUSTED TO 0.2 MA.  
WITH NO INPUT SIGNAL

###### GRID LEAK

45	VOLTS
RETURN TO CATHODE	VOLTS
---	
1	MEG OHM
5	MEG OHMS
250	$\mu\mu\text{f}$

<sup>A</sup> MAXIMUM DC PLATE CURRENT SHOULD BE LIMITED TO 5.0 MA.

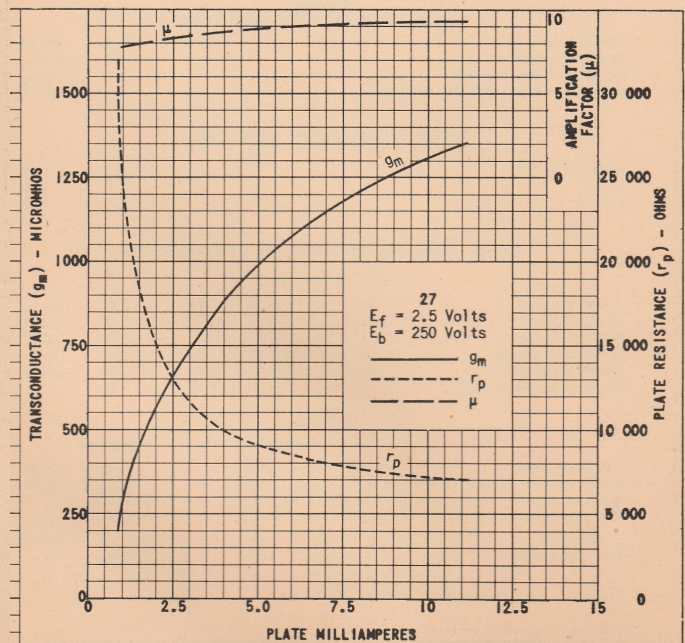
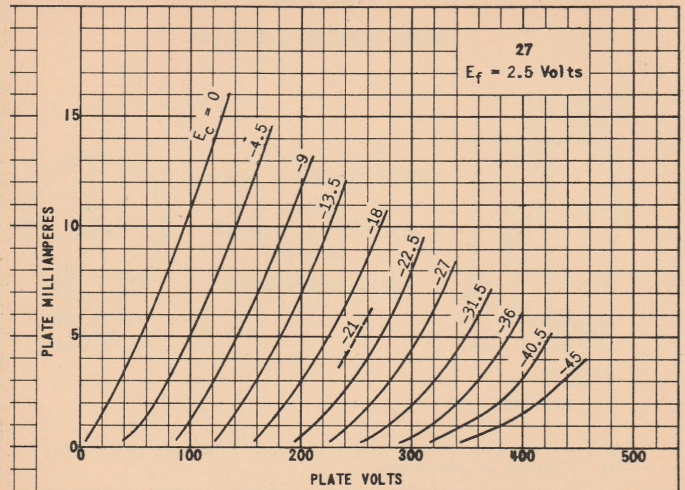

## HVRA 2020 CONVENTION UPDATE by Jerry Sirkin

The 2020 Convention will be held at the Marriott North Hotel on Friday and Saturday, February 7th and 8th. Overnight guests may check-in as early as Thursday and check-out as late as Sunday. For all HVRA guestroom reservations confirmed prior to January 27, 2020, the discounted room rate will be \$85.00 per night, including Wi-Fi. Room reservations can be made through the Marriott weblink (see HVRA.org) or by calling directly to 281-875-4000 and identifying yourself as a member of the Houston Vintage Radio Association. If you have any difficulties booking your room(s), please contact me at 281-844-4124 or gsirkin@aol.com).

As in past years, the Marriott is also discounting their buffet breakfast to \$15.00 (including tip and gratuity) for Fri. – Sun. Coupons will be given to all HVRA members attending the Convention and their family guests (you do not need to be an overnight guest to receive this discounted breakfast).

Convention Events will include: Old Equipment Contest Room, Three Auction Sessions, Swap Meet, Raffles, Westinghouse Radio and/or KDKA technical presentation session(s), Cash Concessions on both Friday (late afternoon) and Saturday (approx. noon), Saturday Awards Banquet Dinner with Guest Speaker Dan Gallo from Country Legend FM Radio 97.1.

**Manufacturer and Theme for this Convention: Westinghouse Radio, Its Development and Marketing.** In addition, we will be recognizing the Pittsburg broadcasting station, KDKA, for its November 20, 1920, entrance into commercial broadcasting. **So...that was the easy part....now I need your help.** I am looking for an HVRA member to volunteer to be the technical speaker on Friday. This could include a show and tell of a Westinghouse radio/tv collection, and/or a Westinghouse radio/tv repair session and/or a discussion of the events leading up to George Westinghouse successfully marketing his radios (and TVs). I would like to also have a short session concentrated on the introduction of Westinghouse's broadcast station KDKA. Please contact me at 281-844-4124

### AWARDS BANQUET GUEST SPEAKER DAN GALLO

Dan Gallo, a.k.a. "The G-Man", radio market since 1971, after ing elsewhere, mostly out of show, "The Gallo Go 'round", where his probationary period Dan has five Texas-born kids, include classic cars, classic cent/guide on the Battleship Houston history.



has been knocking around the Houston nine years of getting his on-the-job train-state. He's been hosting the morning on Country Legends 97.1 for ten years, is about to conclude. and two Texas-born grand-kids. Hobbies aircraft, and a past volunteer as a do-Texas. He also has a keen interest in

Every Monday and Thursday at 7:15, Dan's Uncle Guido calls in to provide a little friendly harassment. Guido is a "colorful" character with a somewhat "checkered" past. There are just some questions he won't answer, a form of "Don't ask, don't tell". , Tuesdays, Wednesdays, and Fridays at 7:15, it's "Uncle Dan's Story Time". Stories that, for the most part, are memorable. The rest....well, you'll forget them before they become a problem

(Edited from 97.1 FM Website)

See the following Grid Leak pages for additional convention information and registration. Pre-registration forms can also be found at HVRA.org.

**HVRA 2020 ANNUAL CONVENTION REGISTRATION and MEMBERSHIP FORM**

*(For Questions Please Contact Jerry Sirkin at 281-844-4124 or [gsirkin@aol.com](mailto:gsirkin@aol.com))*

Last Name: \_\_\_\_\_ First Name: \_\_\_\_\_

Address: \_\_\_\_\_

City: \_\_\_\_\_ State: \_\_\_\_\_ Zip: \_\_\_\_\_

Phone: (\_\_\_\_) \_\_\_\_\_ Ham Call: \_\_\_\_\_

E-mail: \_\_\_\_\_

**All Bidders and Sellers Must Register and Be Active HVRA Members**

Feb. 7 – 8, 2020 Houston Marriott North	NUMBER	AMOUNT
Advance Registration: ** \$15 (Postmarked by 1/25/2020)		\$
On-Site Registration: ** \$20		\$
**Annual Membership \$20: (2/1/2020 – 1/31/2021) NEW		\$
**Annual Membership \$20: (2/1/2010 – 1/31/2021) RENEWAL		\$
Awards Banquet Dinner: Sat. Feb. 8 @ 6:30pm	.....	.....
Chicken Dinner: \$30 per Adult		\$
Child Plate (12 and under): \$15.00		\$
Vegetarian Dinner – \$30.00 per Adult		\$
Vegetarian Dinner - \$15.00 per Child		\$
Swap Meet: 1st Table Free ; Additional Tables - \$10 each; Any member needing a table(s) must contact Jerry prior to Feb. 1 <sup>st</sup>		\$
Grand Totals	.....	\$

- **\*\*Only One Registration Required Per Family (One Bidder Number)**
- **HVRA Commissions: Individual Sellers at 15%**
- **Estates Sales Commissions Pending Pre-Convention Agreements**
- **Buyers and Sellers Settlements at Conclusion of Each Day's Auction Activities (Numerical Order)**

Fri. evening & Sat. lunch cash concessions? Yes\_\_\_ Number: \_\_\_\_\_ No: \_\_\_\_\_ Unsure: \_\_\_\_\_

**ADVANCE REGISTRATION:** CHECKS, PAYABLE TO HOUSTON VINTAGE RADIO ASSOCIATION (HVRA), or CASH MUST BE POSTMARKED BY JANUARY 25, 2020 to:

**Jerry Sirkin 17614 Fairway Oaks Drive Spring, Texas 77379**

**ON-SITE:** AFTER JAN 25, 2020, BRING REGISTRATION FORM AND CHECK/CASH TO CONVENTION

**HVRA USE ONLY:**

**DATE RECEIVED:** \_\_\_\_\_ **CHECK NUMBER:** \_\_\_\_\_ **CASH:** \_\_\_\_\_

**REGISTRATION (BIDDER) NUMBER:** \_\_\_\_\_

**The 2020 Convention Gazette**  
**Tom Taylor Convention Contest Chairperson**

We are about 4 months away from another opportunity to claim a ribbon at the once-a-year HVRA Old Equipment Competition among our peers. Before I continue, I would like to take a moment to thank Jeff Heller again for covering my tail at last year's event. Also, thanks to all of the contestants for their efforts to be recognized of their entrees and their collecting and restoration skills. I salute you all and hope to see you again next February.

In brief, we will let it ride, i.e. replicate nearly all of last years' rules and categories with one notable exception: As was the case last year, all members registered for the Convention will be allowed to vote for the "Peoples' Choice Award. However, only one vote per registered family is allowed....so if you attend with another family member, you will only receive one ballot for this award.

Only Old Equipment Contest entrants can vote to select The Exhibitor's Award.

**Judging Criteria:**

- Rare Unique and Unusual
- Condition/Quality
- Documentation or Description
- Authenticity
- Presentation, Showmanship and Contestant Effort

NOTE: Last year I saw the judges' commentaries hinge in favor of numbers 3 and 5 (above) when a pair of otherwise excellent well restored and rare items were deemed worthy. Let's make it as tough as we can for them this year and ..... bring it on.

**Awards: ..... you have several chances to bring home the colors**

First Place per category

Second Place per category

Top Awards in: Best Restoration

Vintage Equipment

Collections

New Contestant

Peoples' Choice

Exhibitor's Award (\$50 Gift Card) Each entrant will receive one ballot per display.

If you have any questions about the Old Equipment Contest, please contact Jerry Sirkin or Tom Taylor (281-229-2970 or ihcrally@yahoo.com).

## 2020 OLD EQUIPMENT CONTEST

### CONTEST RULES

All contestants must register for the Convention and be an active member in good standing.

Previous displays winning First Place in 2018 and 2019 contests may not be entered in the competitive categories of the 2020 contest. These items may, however, be shown as non-competitive displays.

A contestant may enter as many as two displays per category. A display is eligible for only one category.

Contestants must complete an entry card for each display and failure to declare a category is a disqualification from any award.

Reproductions must be properly identified as such.

All displays must be in good, clean, showable condition. Displays in un-showable condition may be disqualified and removed from the contest at the discretion of the Contest Chairperson.

The Contest Chairperson will determine the appropriateness of questions or issues regarding displays and any other rule interpretation.

In case of a tie, the judges or Contest Chairperson may request a functional demonstration of both devices.

No fee will be charged for entering the Contest.

All displays must be in place no later than one hour prior to judging, on the Contest Saturday.

Devices of foreign manufacturers may compete in any appropriate category.

Contestants must refrain from discussing displays with judges. If judges have questions pertaining to a display, they must be voiced to the contestant through the Contest Chairperson.

These Rules may not cover all issues that arise in relation to the HVRA Old Equipment Contest. The Contest Chairperson has the discretion to make any decisions necessary in relation to Contest to insure a fair and orderly Contest.

### CATEGORIES

1. Wireless/Spark Equipment
2. Crystal Receivers and Related Crystal Equipment
3. 1920s Battery Receivers
4. Cathedrals, Tombstones and Consoles (wood)
5. Table Receivers, Tube (wood)
6. Table Receivers, Tube (non-wood)
7. Transistor or other Portable Radios
8. "Modern" Electronics, Items at least 10 yrs. old. Examples include: Computers, Newer Radio Equipment, Game Consoles, Calculators, Unique Electronics, Portable HI-Fi (Walkman, Boom Box, etc), and lastly Amateur Radio Equipment Too Young For Category 13
9. Phonographs, Speakers, Reproducers, Microphones
10. Miscellaneous Vintage Electrical Equipment (Examples include Telephones, Telegraph, Scientific Test Equipment, Electrical Devices and Television)
11. Kit Radios and Equipment (At Least 10 Yrs. Old)
12. Hi-Fidelity Equipment
13. Amateur Radio Equipment (At Least 10 Yrs. Old)
14. Military Electrical and Electronic Equipment
15. Replicas and Vintage Style Creations
16. Foreign Radios
17. **Special Convention Theme**: Westinghouse Radios and Westinghouse Radio Related Electronics. This could include radios, radio test equipment, phonographs, documents, or other items and materials that represent the founding and growth of Westinghouse as a radio manufacturer.
18. **KDKA** Literature and/or Artifacts representing the entry of Westinghouse into the Broadcast industry
19. Components, including Vacuum Tubes
20. Open Display

## Buy, Sell, Trade, & Services Offered

**Vintage Sounds** Radio & Phonograph Sales & Repair including vintage auto radios, battery sets, foreign sets, etc. We also sell and service vintage telephones and telegraph equipment also parts, new & used tubes, transformers, schematics, books, phonograph parts & needles, records, etc. **Vintage Sounds** celebrating our 33<sup>rd</sup> year in business. Open Friday, Saturday, & Sunday from 10 until 6 PM. Now located in The Market Place Antiques, 10910 Old Katy Road, in Houston (Located about two blocks west of the Athena Gun Club on the westbound I-10 feeder road). 10% member discount on radio items. (713) 468-4911 [www.vintagesoundshouston.com](http://www.vintagesoundshouston.com)

**Borden Radio Company** website: <http://www.xtalm.com> Antique Radio Schematic Service included in web-site. Crystal radio kits for sale. (281) 620 – 6692

**Sargent Auction Service:** [www.sargentauction.com](http://www.sargentauction.com), [Jims@sargentauction.com](mailto:Jims@sargentauction.com) Jim Sargent, WA5QBR, Auctioneer, TX license 16135 | 200 Thomas Road, Granbury TX 76049

**Allen Speaker Service:** Speaker re-coning and repair, 919 W. 19th St. Houston, (713) 862-2747.

**Tom Granger Restorations**, radio and phono cabinets. (281) 338 - 8277.  
[www.tomgranger@mac.com](http://www.tomgranger@mac.com)

**For Sale:** Working guaranteed National SW3 receiver with the 2.5 volt tubes and home brew power supply. Works great with aging components replaced in good workmanship manner. A pair of coils may be extra depending on final price and several coils may become available. Cosmetically at least an 8 without dents, or scratches. The power supply has been optimized and is in finished cosmetic and functional form. Plug and GO Asking \$175 OR reasonable offer. Tom Taylor (281) 229 2970

**Moving Sale:** Extensive collection of test equipment, using tubes and semiconductors. Old computers from 1960s to 2000. All types of parts, vintage communication receivers and transmitters, metal cabinets, and more. Sale to begin about October 10th. Email Jimmie Stewart for a list at [jimmietex@netzero.net](mailto:jimmietex@netzero.net).

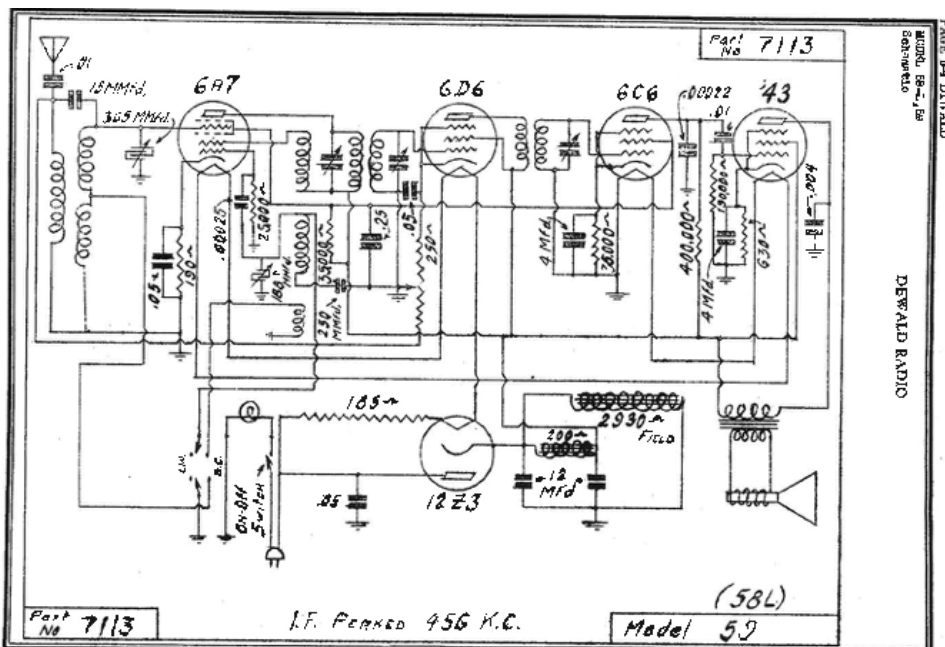

DeWald Radio Model 59  
Does anyone have an idea of what type of bulb in on the grounded side of the on-off switch? It is a miniature screw type, but it sure looks like it has to carry all of the current of the filaments and everything else.  
Please contact me at:  
281-493-0737,  
[britfam1@juno.com](mailto:britfam1@juno.com).  
Thank you, Lewis Brittain

## Other Radio Related Activities

**Texas Broadcast Museum:** This museum is located at 416 E. Main Street in Kilgore, TX, phone 903-984-8115. There are hundreds of pieces of vintage paraphernalia related to radio and TV broadcasting. Admission is \$6.00 (\$5.00 for seniors and military vets).

**Edington Family Museum of Atwater-Kent Radios:** Jimmy Edington, long-time collector and original HVRA member, has re-purposed a beautifully restored hotel to display his outstanding collection of Atwater-Kent radios and related products. It is located in Silsbee, TX, about 80 miles east of Houston. See his website, [www.atwaterkentrus.com](http://www.atwaterkentrus.com). If you would like to visit, please contact Jimmy in advance, 337-476-4328 or [atwaterkentrus@gmail.com](mailto:atwaterkentrus@gmail.com)

## Local Sources for Radio and Electronic Parts

**EPO (Electronic Parts Outlet)**, 3753 Fondren Rd., Houston 77063 (713) 784 – 0140  
**ACE Electronics**, 3210 Antoine Dr., Houston 77092 (713) 688-8114

## More Radio Clubs

**Oklahoma Vintage Radio Collectors** President: Jim Collings, PO Box 50625, Midwest City, OK [jcradio@cox.net](mailto:jcradio@cox.net); \$15 annual dues. Monthly meetings, annual show.

**Antique Radio Club of Illinois**, [www.clubinfo@vintage-radio.org](http://www.clubinfo@vintage-radio.org)

**Collins Radio Association (CRA)**. David Knepper, PO Box 34, Sidman, PA 15955. No dues. [www.collinsra.com](http://www.collinsra.com)

**Louisiana & Gulf Coast Antique Radio Club**. Phil Boydston, 750 Moore St., Baton Rouge, LA 70806.

**Michigan Antique Radio Club (MARC)**. Don Colbert, MARC, Pub: The Michigan Antique Radio Chronicle, quarterly. Dues: \$20. [membership@michiganantiqueradio.org](mailto:membership@michiganantiqueradio.org). Annual Extravaganza and other quarterly meets. [www.michiganantiqueradio.org](http://www.michiganantiqueradio.org)

**New Mexico Radio Collectors Club (NMRCC)**. Monthly newsletter and members meeting (with flea market, auction and theme program). Dues: \$20. For more information contact John Anthes, [jpanthes@comcast.net](mailto:jpanthes@comcast.net) Club website: <http://newmexicoradiocollectorsclub.com>

**Texas Antique Radio Club**, Doug Wright, Canyon Lake, TX. [wrightdougas70@yahoo.com](mailto:wrightdougas70@yahoo.com)

**Vintage Radio and Phonograph Society (VRPS), Dallas / Ft. Worth, TX**. George Potter [vrps@sbcglobal.net](mailto:vrps@sbcglobal.net), website: [www.vrps.org](http://www.vrps.org)

**Texas Panhandle Vintage Radio Society (TPVRS)**. Contact: Elroy A. Heras, 4086 Business Park Dr., Amarillo, TX 79110

**Antique Radio Collectors Club of Ft. Smith, Arkansas (ARCC)**. Paul Tucker, 4700 N. "N" St., Fort Smith, AR 72904. Dues: \$10. Monthly meetings, annual show.